

Tungsten halogen lamps for airfield lighting

Table 1 – Reflector lamps, for series operation at 6.6 Ampere

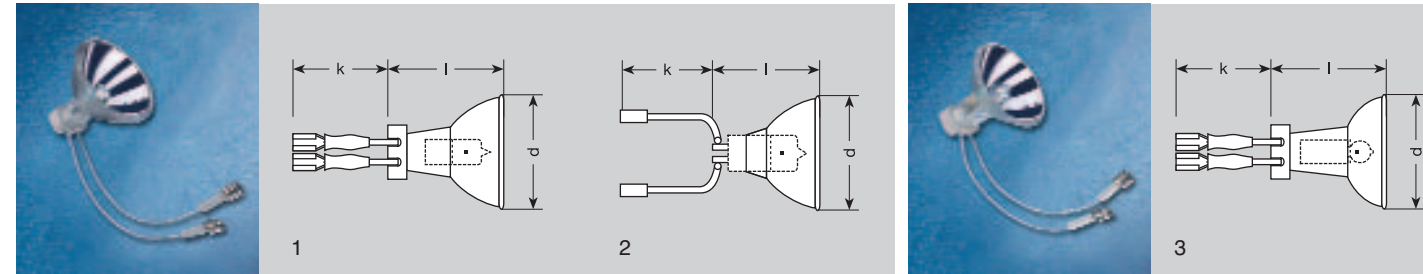

Lamp reference	Wattage (W)	Average life ¹⁾ (h)	Min. luminous intensity ²⁾ (cd)	Max. d (mm)	Max. l (mm)	Min. k (mm)	Connector	Fig.
64331SP-A (spot reflector)	30	1000	16000	50.2	45.6	130	female ³⁾	1
64331FL-AC (flood reflector)	30	1000	3700	50.2	45.6	130	female, male ³⁾	1
64333-A	40	1500	10000	35.3	37.0	130	female ³⁾	1
64333-B	40	1500	10000	35.3	37.0	130	female, round ³⁾	1
64333-C	40	1500	10000	35.3	37.0	125	male ³⁾	1
64337A45-15	45	1500	19000	50.2	45.6	125	female ³⁾	1
64337B45-15	45	1500	19000	50.2	45.6	130	female, round ³⁾	1
64337C45-15	45	1500	19000	50.2	45.6	130	male ³⁾	1
64337A48-10	48	1000	23000	50.2	45.6	125	female ³⁾	1
64337A48-15	48	1500	20000	50.2	45.6	125	female ³⁾	1
64337B48-15	48	1500	20000	50.2	45.6	125	female, round ³⁾	1
64337C48-15	48	1500	20000	50.2	45.6	125	male ³⁾	1
64337IRC-LL-A	48	3000	20000	50.2	45.6	125	female ³⁾	3
64337IRC-LL-B	48	3000	20000	50.2	45.6	125	female, round ³⁾	3
64337IRC-LL-C	48	3000	20000	50.2	45.6	125	male ³⁾	3
64339-A	105	1000	30000	50.2	45.6	125	female ³⁾	2
64339-B	105	1000	30000	50.2	45.6	130	female, round ³⁾	2
64339-C	105	1000	30000	50.2	45.6	125	male ³⁾	2
64339-AC	105	1000	30000	50.2	45.6	125	female, male ³⁾	2

Burning position: any

Table 2 – Lamps with PK30d base, for series operation at 6.6 Ampere

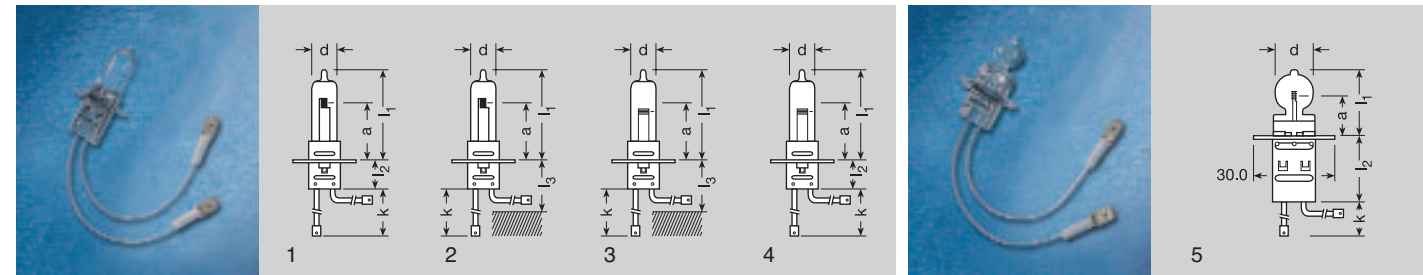

Lamp reference	NAED	LIF	Wattage (W)	Average life ¹⁾ (h)	Luminous flux (lm)	Connector	Filament	Approx. filament dimensions (mm x mm)	a ²⁾ (mm)	Max. d (mm)	Max. l ₁ /Max. l ₂ (mm)	Min. l ₃ required ³⁾ (mm)	Min. k (mm)	Fig.
64317	58705	J1/76	45	1000	800	male	C 8	1.4 x 3.6	16	13.5	37/21	-	115	1
64317IRC-LL-C			45	3000	800	male	C 8	1.4 x 3.6	16	13.5	37/21	-	115	5
64318		J1/77	45	1000	800	female	C 8	1.4 x 3.6	16	13.5	28/-	27	115	2
64318 Z			45	1000	800	male	C 8	1.4 x 3.6	16	13.5	28/-	27	115	2
64319			45	1000	800	female	C 8	1.4 x 3.6	20	13.5	32/-	23	115	2
64319 Z			45	1000	800	male	C 8	1.4 x 3.6	20	13.5	32/-	23	115	2
64319IRC-LL-A			45	3000	800	female	C 8	1.4 x 3.6	20	13.5	32/-	23	115	5
64319IRC-LL-C			45	3000	800	male	C 8	1.4 x 3.6	20	13.5	32/-	23	115	5
HLX 64328			65	1000	1450	female	CBar-6	3.3 x 3.2	20	13.5	32/-	21	115	3
HLX 64328 Z			65	1000	1450	male	CBar-6	3.3 x 3.2	20	13.5	32/-	21	115	3
HLX 64341	58709	J1/79	100	1000	2700	female	CBar-6	5.4 x 3.0	20	13.5	32/-	23	115	3
HLX 64341 Z			100	1000	2700	male	CBar-6	5.4 x 3.0	20	13.5	32/-	23	115	3
HLX 64342	58706	J1/80	100	1000	2700	male	CBar-6	5.4 x 3.0	20	13.5	41/17	-	115	4
HLX 64361		J1/83	150	1000	3600	female	CBar-6	7.2 x 3.6	20	13.5	35/-	23	115	3
HLX 64361 Z			150	1000	3600	male	CBar-6	7.2 x 3.6	20	13.5	35/-	23	115	3
HLX 64382	58708	J1/84	200	1000	4800	male	CC 6	7.1 x 3.9	20	13.5	43/21	-	115	4

Burning position: s 90 (vertical-to-horizontal, base down)

Table 3 – Single-ended and double-ended lamps, for series operation at 6.6 Ampere

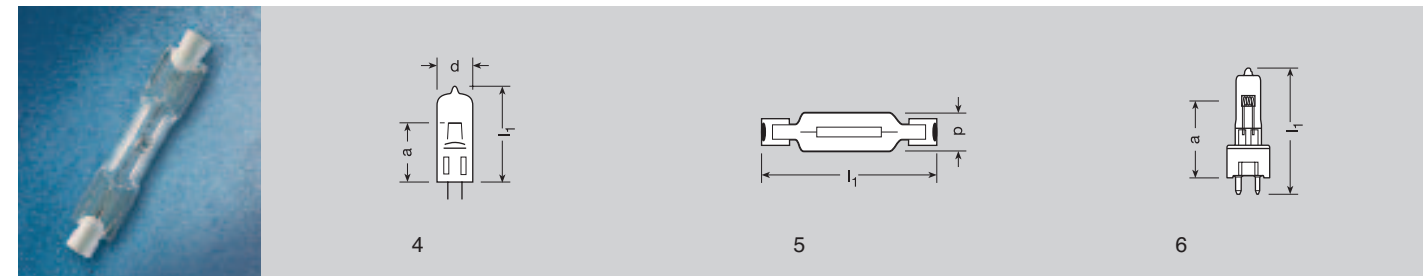
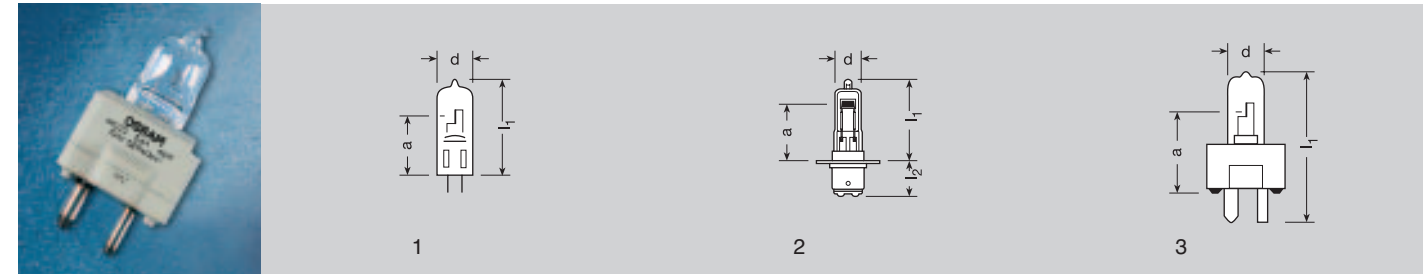

Lamp reference	NAED	LIF/ANSI	Wattage (W)	Base	Average life ¹⁾ (h)	Luminous flux (lm)	Burning position	Filament	Filament dimensions (mm x mm)	a (mm)	Max. d (mm)	Max. l ₁ /l ₂ (mm)	Fig.
58746	58821		200	P30d	1300	5200	any	CC-6	5.5 x 3.8	27	13.0	60.3/20.6	2
58750	58789	EZL	200	GZ(GY)9.5	1300	5200	s 90	CC-6	5.5 x 3.8	39.1	13.0	65	3
58793	58819		115	P30d	1100	2900	any	CBar-6	6.5 x 3.1	26.9	13.0	39.7/20.6	2
58798	58794	EVW	115	GZ(GY)9.5	1100	2900	s 90	CBar-6	6.5 x 3.1	39.1	13.0	65	6
58799	58795		175	GZ(GY)9.5	1000	4700	s 90	CBar-6	6.6 x 4.2	39.1	13.0	65	3
64311		J1/59	36	G 6.35	1200	610	s 90	C-8	1.3 x 3.3	33	11.0	45	1
64315	58704	J1/78	45	R 7 s	1000	750	any	C-8	4.0 x 1.5	-	8.8	47.5	5
64320		EXM	45	GZ 9.5	1000	875	s 90	C-8	1.4 x 3.3	25.4	11.0	44.5	3
64321		J1/57	45	G 6.35	1200	840	s 90	C-8	1.3 x 3.6	33	11.5	45	1
64322	58779	EXL	30	GY(GZ)9.5	2000	400	any	C-8	-	25.4	11.5	44.5	3
64340		J1/82	100	R 7 s	1000	2000	any	CC-8	6.0 x 2.6	-	12.0	60.2	5
64346		J1/58	100	G 6.35	1200	2300	s 90	CBar-6	4.6 x 3.0	33	13.5	47	4
64354	58777	EWR	150	GY(GZ)9.5	1500	4000	any	CBar-6	-	39.1	13.0	56.5	3
64380	58707	J1/40	200	R 7 s	1000	4400	any	CC-8	10.0 x 3.0	-	15.0	60.2	5
64386		J1/39	200	G 6.35	1200	4700	s 90	CBar-6	6.9 x 4.5	33	13.5	47	4

Small socket stone for 45 and 48 W reflector lamps

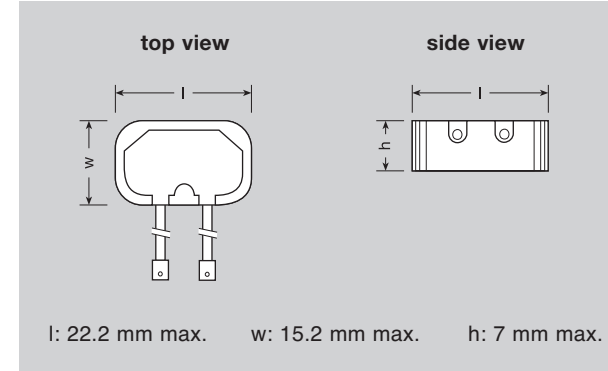

General information

Sales and deliveries are subject to the OSRAM terms of supply and payment valid on the day the sales agreement is signed.
Operating data and dimensions are subject to the usual slight tolerances.
OSRAM reserves the right to make technical modifications without notice. All supplies subject to availability.

Connectors for reflector and PK30d lamps

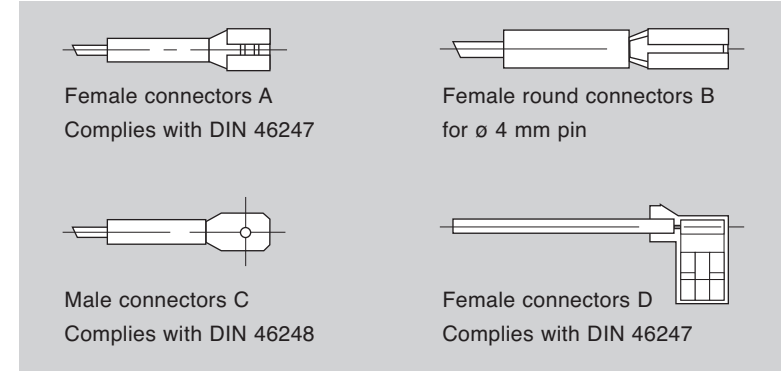

- ¹⁾ At 6.6 A
- ²⁾ At 0° direction and at 6.6 A
- ³⁾ No socket stone
- ⁴⁾ With socket stone
- ⁵⁾ Small socket stone
- ⁶⁾ Reference plane for length a is the upper plane of the adjustment ring; this must be considered when designing optical systems
- ⁷⁾ Dimension l₃ is to be understood as minimum required free space to be provided in a fixture

122 D04-E 10/03 Pa OSRAM CS CC Subject to alteration Printed on chlorine-free bleached paper



The reliable guiding stars

Effective solutions for airfield lighting: Tungsten halogen lamps and the innovative IRC technology

The right lamps for the right applications

Tungsten halogen technology

Reliability, longevity and reasonable maintenance costs account for the success of tungsten halogen lamps as light sources for demanding airfield lighting applications.

Tungsten halogen lamps offer a number of features which make them more suitable for airfield lighting systems than any other lamp technology. They can be operated well below rated current with intensities down to 1/10.000 of full intensity and are thus the light source of choice in all visibility conditions, day or night. Their small bulb dimensions and high luminance enable compact lights to be constructed with low protrusion over ground. All in all, they represent state-of-the-art lighting technology for airfield applications.

Pre-focus technique

Simple replacement and easy adjustment reduce maintenance costs.

Lamps with PK30d bases offer an unsurpassed precision of filament alignment and make adjustments unnecessary. Lamps with integrated reflectors are optical systems designed to be mounted at the reflector rim. They, too, allow for quick replacement without any additional adjustment. All in all, pre-focusing translates into the same light output after lamp replacement with no adjustment effort.

Cable connection

Heat is the main enemy of any high wattage lamp placed in an enclosed luminaire. This is particularly true for inset lights that are exposed to direct sunshine and surrounded by hot concrete.

Cable connections allow electrical contacts to be placed away from the pinch seal. This reduces the twin risks of pinch seal overheating and molybdenum foil oxidation, which are the two main reasons responsible for shortening the lamp life.

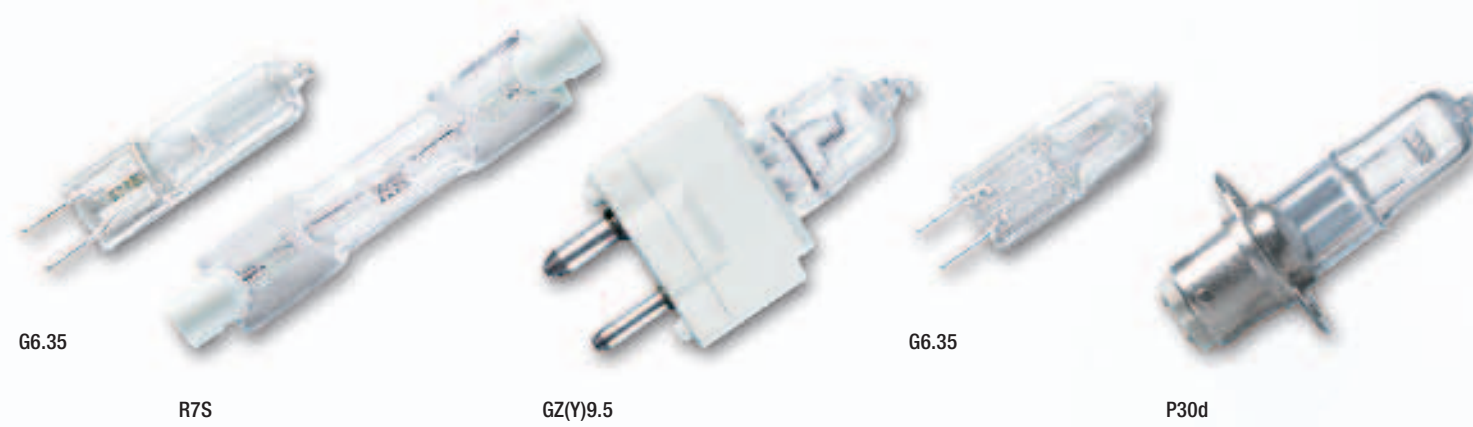
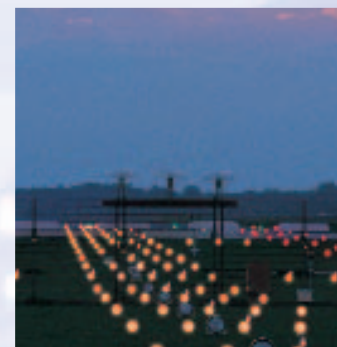
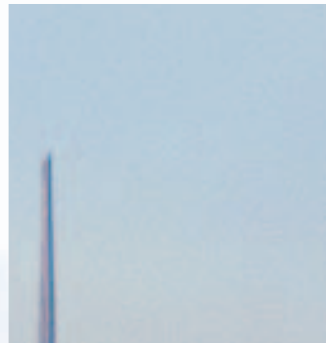

Xenophot® technology

Just a little more light can make all the difference.

Using xenon instead of krypton as the filling gas increases the luminous efficacy of a lamp – that's the basic idea behind our XENOPHOT® technology. Such lamps make it easier to comply with the international standards and recommended practices of aviation authorities. They generate more light output for the same power consumption than their krypton counterparts.

Cold beam reflector technology

Because of their small prisms, inset lights with very low projection above ground place very high demands on the directional precision of the light beam.

Halogen burners have to be meticulously adjusted in optimised parabolic reflectors for maximum effect. These ready-made pre-focused optical systems generate very narrow light beams of unsurpassed directional precision. Cold beam reflectors prevent heat from being concentrated on optical parts of luminaires such as filters, lenses or prisms. Reflector lamps are indispensable for independently switchable bidirectional lights and can therefore be thought of as the ideal light source for the airfield lighting of tomorrow.

IRC technology (Infrared Reflective Coating)

Halogen lamps don't just produce light. 60% of the generated radiation are infrared (IR) rays. The innovative IRC technology increases the efficiency of halogen lamps by reflecting a major part of the generated useless IR radiation back to the coil where it is converted into visible light. The infrared reflective coating at the outside of the burner acts as an IR mirror but lets nearly 100% of visible light pass (see figure 2).

In comparison to standard halogen lamps it is possible to optimise the lamp in different directions by using the IRC-process:

- more light output
- less electrical power
- increased lifetime
- or
- a mix of all



IRC Reflector Lamp
48 W, 6.6 A



IRC PK30d
45 W, 6.6 A



Standard PK30d
45 W, 6.6 A



IRC-Airfield lamps

Ways to save on maintenance costs.

New series of lamps for airfield lighting systems offers significantly increased lamp life.

Example 1:
Standard 48W, 6.6 A reflector lamp (64337 LL – Long Life) with 3000 h lifetime.

NEW – 48W, 6.6 A reflector lamp (64337 LL – Long Life) with 3000 h lifetime.

Example 2:
Standard 45W, 6.6 A PK30d based lamp (64317, 64319) specified with 1000 h lifetime.

NEW – 45W, 6.6 A, PK30d based lamp (64317 LL, 64319 LL – Long Life) with 3000 h lifetime.

Substitute your standard lamps with new long life versions.

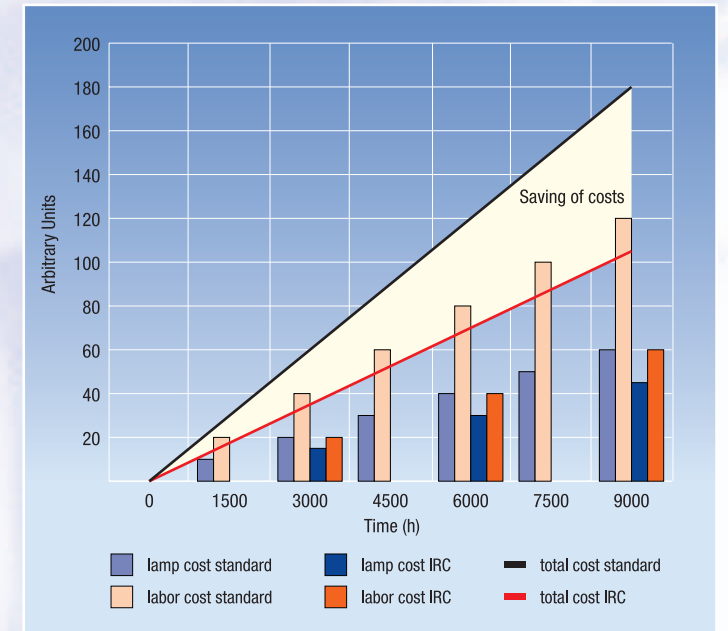

Figure 1: Accumulated saving of costs (through extended replacement intervals) when using IRC-Airfield lamps instead of standard lamps

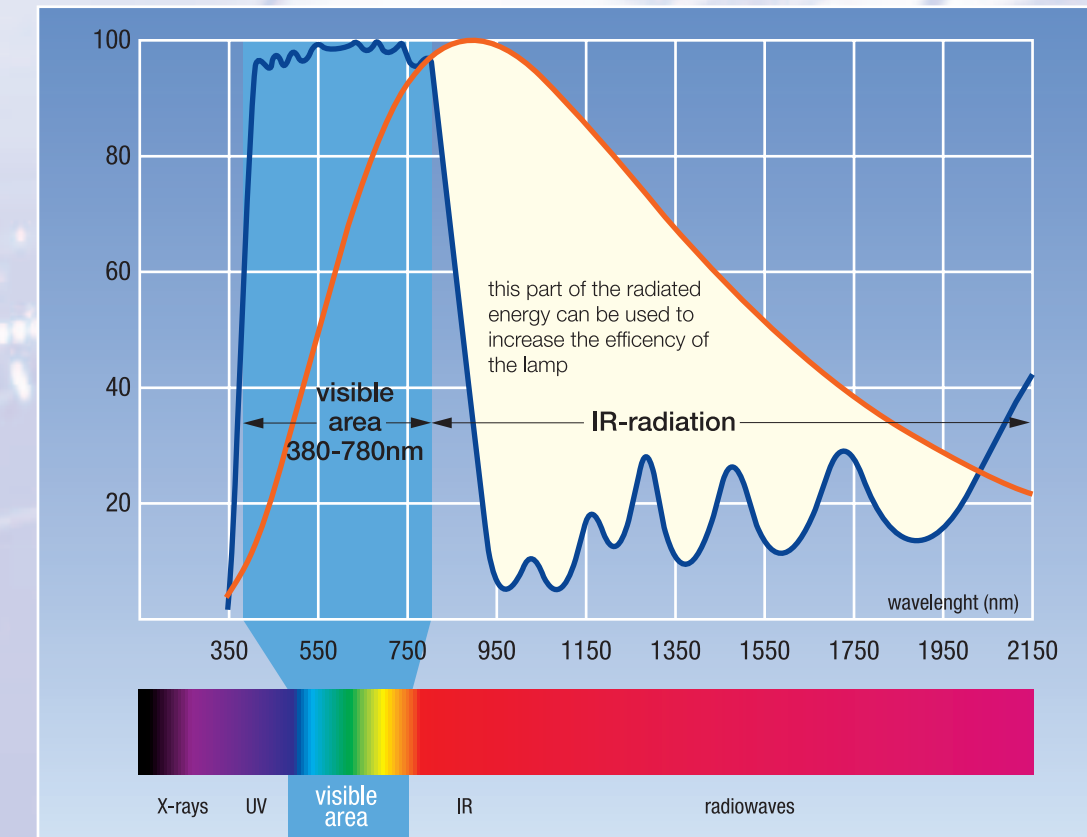

Figure 2: IRC-Airfield lamps, sphere of activity

