

GFDS400-G1 827-05

GINOLED FLEX Diffuse Side |



Характеристики продукта

- 3 SDCM, CRI80
- Large selection of lighting color temperatures
- 110° viewing angle per module
- Up to 50,000 h lifetime @ tc max

Преимущества продукта

- Cut to length each 41.7 mm
- 10x10 mm super slim design, fit for embedded applications
- Diffuse version, side emitting, high light uniformity without spot or dark area
- IP67 protection for truly outdoor application

Области применения

- Outdoor and indoor contour lighting
- Информационные панели
- Закарнизное освещение
- Декоративное освещение
- Architectural lighting
- Направленное освещение



Техническое описание продукта

Technical data

Электрические параметры

Номинальная мощность в ваттах на метр	6,0 Вт
---------------------------------------	--------

Фотометрические данные

Цветовая температура	2700 K
Индекс цветопередачи Ra	80
Цветность света (обозначение)	2700 K
Стандартное отклонение эллипса соотв.	≤3 sdcм
Световой поток на метр	410 лм
Общий полезный световой поток	2050 лм

Светотехнические параметры

Угол излучения	0 °
Время зажигания	0,0 s
LED pitch	6.95 mm
Время разогрева (60 %)	0,00 s

Информация о светодиодном модуле

Кол-во светодиодов в мин. отрезке	6
Количество светодиодов на метр	144

Размеры и вес

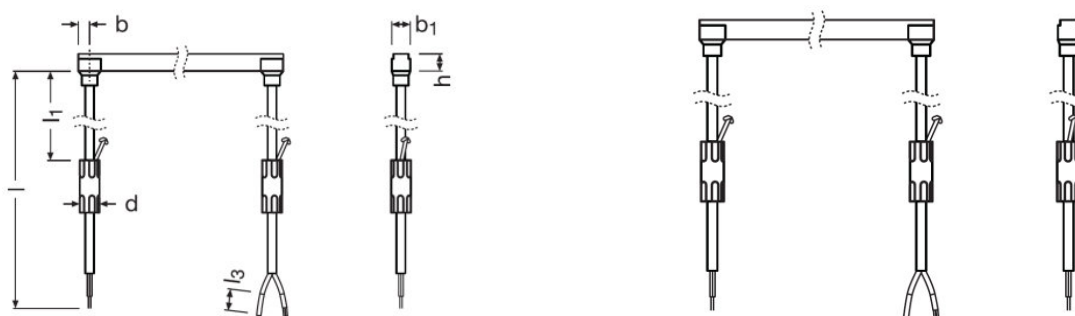

Вес продукта	650,00 g
Длина минимального отрезка	41.7 mm
Длина	5000 mm
Ширина	11,0 mm
Высота	10,5 mm

Техническое описание продукта

Длина кабеля	665,0
--------------	-------

Цвета и материалы

Материал корпуса	Silicone
Материал покрытия (колбы)	Silicone

Температуры и условия управления

Диапазон температуры окружающей среды	-40...+55 °C
Предел раб.темпер.согласно IEC 62717	RG0

Срок службы

Количество циклов переключения	15000
Срок службы лампы	50000 h
Спад свет.потока в течение срока службы	0,70
Номинальный срок службы	50000 h

Возможности / мощности

Lowest bending radius	100 mm
With end piece	Нет
With connection set	Да
Control interface	-
Detection angle (Light sensor)	-
Detection angle (PIR)	-

Сертификаты и Стандарты

Тип защиты	IP67
Энергопотребление	33 кВт·ч/1000 ч

Условия поставки



Код заказа	85395100000
------------	-------------

Environmental information

Information according Art. 33 of EU Regulation (EC) 1907/2006 (REACH)	
Date of Declaration	24-06-2022
Primary Article Identifier	4062172194242
Candidate List Substance 1	No declarable substances contained
Declaration No. in SCIP database	No declarable substances contained

Техническое описание продукта

Загрузка данных

Файл	
	User instruction GinoLED Diffuse White Flex
	Declarations of conformity GFD SW TW CE 4283939 180823
	Declarations of conformity GINOLED FD TW UK CE 4237513 040221

Ecodesign regulation information:

- This product is considered to be a "containing product" in the sense of Regulations (EU) 2019/2020 and (EU) 2019/2015.
- Tolerances of the reported values, are according to LED Modules Performance standard IEC/EN 62717.
- In general, the replacement of the contained light sources without permanent damage to the product with the use of common available tools is possible in the final application when they can be dismantled from the installation environment and substituted for the necessary number of light sources restoring its full electrical/mechanical/thermal/optical functionality by means of a professional installer. In the contrary, and limited to the LINEARlight Flex Diffuse, LINEARlight Rigid Finesse, GINO LED Flex Diffuse and LUMINENT Milky product families, the contained light source is an integrated part of the containing product and its removal can only be done by causing a permanent damage to the containing product due to its tight mechanical, electrical, optical, thermal interaction and/or environmental protection with or from the containing product. Therefore, a replacement of the light source with the use of common available tools is not justified.
- Dismantling of light sources from containing products at end of life: Containing products with light sources which are scalable in length can be cut to the length of the contained light source and if applicable mechanically detached from protective and/or optical covers. Containing products shall be separated from building material and/or from other additional mounting accessories by means of a professional installer. Separate control gear and light sources must be disposed of at certified disposal companies in accordance with Directive 2012/19/EU (WEEE) in the EU and with Waste Electrical and Electronic Equipment (WEEE) Regulations 2013 in the UK. For this purpose, collection points for recycling centres and take-back systems (CRSO) are available from retailers or private disposal companies, which accept separate control gear and light sources free of charge. In this way, raw materials are conserved and materials are recycled.

Данные для заказа

Product code	Описание продукта	Упаковка (цена/шт.)	Размеры (длина x ширина x высота)	Объем	Вес брутто
4062172194242	GFDS400-G1 827-05	Shipping carton box 3	475 mm x 360 mm x 145 mm	24.80 дм ³	4530.00 г

The mentioned product code describes the smallest quantity unit which can be ordered. One shipping unit can contain one or more single products. When placing an order, for the quantity please enter single or multiples of a shipping unit.

Техническое описание продукта

Примечание

Subject to change without notice. Errors and omission excepted. Always make sure to use the most recent release.